

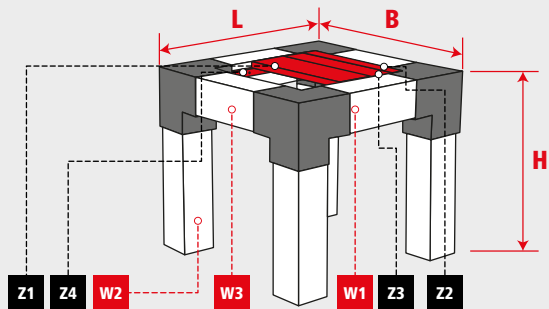











suki

KREATIVPROJEKT #4

EINFACHER SITZHOCKER





B 500mm	L 500mm	H 450mm	 22-28 mm Z1 - Z3
B  4x	N  2x 		 max. 50mm Z4
W1  2x 500mm	W2  4x 360mm	W3  2x 320mm	
Z1  115mm 1x 320mm	Z2  93mm 1x 320mm	Z3  55mm 2x 307mm	Z4  2x 320mm



Hey! Schau dir zur Unterstützung für dieses Projekt unsere passende Aufbauanleitung an. Scanne einfach den QR-Code oder besuche unsere Projektwebseite unter folgender Adresse: suki.com/steckverbinder/

